



### DUAL DIGITAL CONTROLS

Control temperature, time, chromotherapy and reading lights inside or outside your sauna with dual redundant controls.

### ELEGANT DETAILS

Beautiful tongue and groove wood and attention to detail set our furniture quality sauna cabins apart.

### LOW EMF/ LOW ELF

The safest and most effective saunas available with Ultra Low EMF / Low ELF technology.

### BEAUTIFUL ACCENT LIGHTS

Energy efficient LED lights highlight the beauty of your sauna while providing gentle ambient lighting.

### THERAPEUTIC FAR INFRARED HEATERS

Our exclusive True Wave™ hybrid Carbon & Ceramic low EMF far infrared heaters surround you in healing infrared heat.

### ENHANCED AUDIO SOUND SYSTEM



Bluetooth and AUX inputs make it easy to connect and listen to your audio devices.

### 360° HEAT



360° heat to effectively heat your core.

### STRONG CONSTRUCTION



Strong and sturdy construction with a traditional look.

### EXCLUSIVE UNDER FLOOR HEATER



Only Clearlight Essential Saunas include a heater underneath the ceramic floor to enhance your sauna session.

### SPECIFICATIONS

#### Construction

Eco Certified Grade "A" clear Hypoallergenic Nordic Spruce  
6 mm safety glass  
Weight: 193 kg

#### Exterior

Width: 155 cm  
Depth: 112 cm  
Height: 195 cm

#### Interior

Width: 145 cm  
Depth: 100 cm  
Height: 183 cm  
Bench: 142 cm x 51 cm

#### Far Infrared Heaters

True Wave™ Carbon & Ceramic Low EMF/ELF Heaters  
Power: 230 V / 1,850W / 8A

#### Full Lifetime Warranty

Comes with standard chromotherapy, upgrade possible.

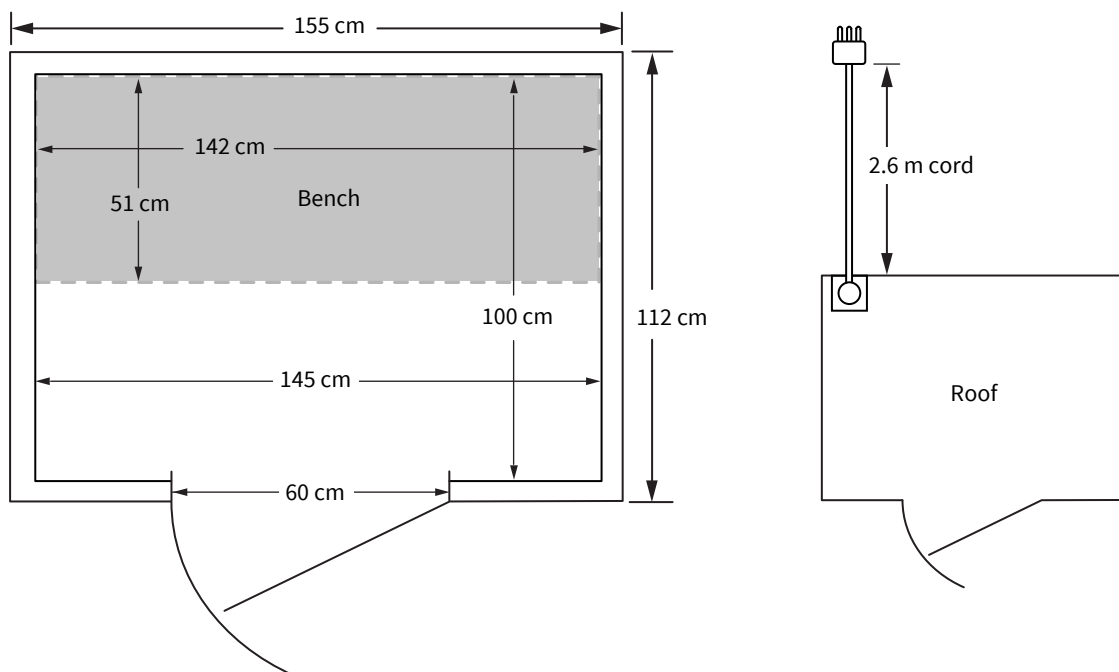
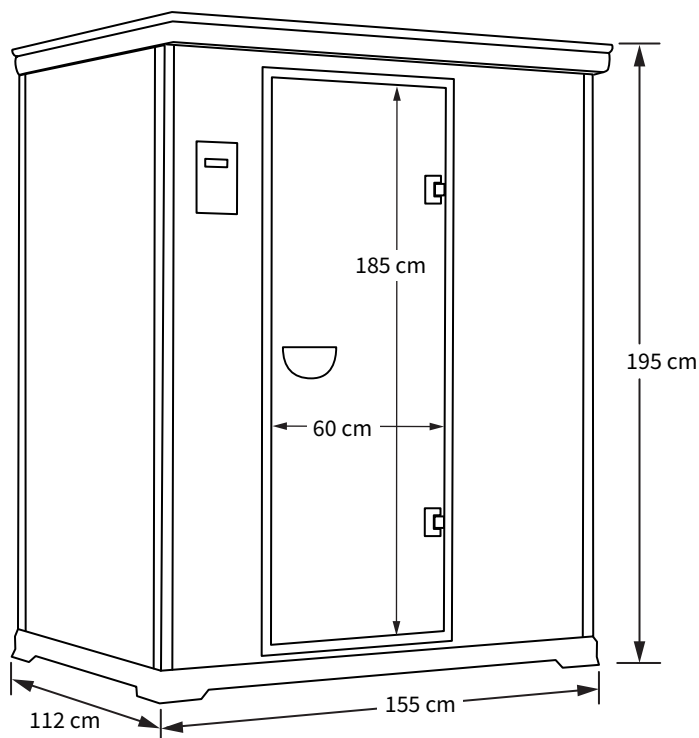

**SPECIFICATIONS**

**Construction**

Eco Certified Grade "A" clear  
Hypoallergenic Nordic Spruce  
6 mm safety glass  
Weight: 193 kg

**Exterior**

Width: 155 cm  
Depth: 112 cm  
Height: 195 cm

**Interior**

Width: 145 cm  
Depth: 100 cm  
Height: 183 cm  
Bench: 142 cm x 51 cm

**Far Infrared Heaters**

True Wave™ Carbon & Ceramic  
Low EMF/ELF Heaters  
Power: 230 V / 1,850W / 8A

**Full Lifetime Warranty**

Comes with standard  
chromotherapy,  
upgrade possible.



# Infrared Sauna Safety: Low EMF / Low ELF

As a trusted health and wellness company, your health is our top priority. That is why our True Wave™ infrared heaters are the safest and most effective on the market today. To prove it, Clearlight® infrared saunas are designed to be the only ones that cancel both EMF and ELF and have the best testing record in the industry.

## What is EMF?

Electromagnetic Fields; EMF and ELF have been called “dirty electricity” and are the unintentional wavelengths produced by things like, computers, appliances, cell phones and electrical wiring. EMF/ELF has increased steadily over the past 50-100 years as our daily use of electronic and labor saving devices has skyrocketed. This has become a real public health concern.

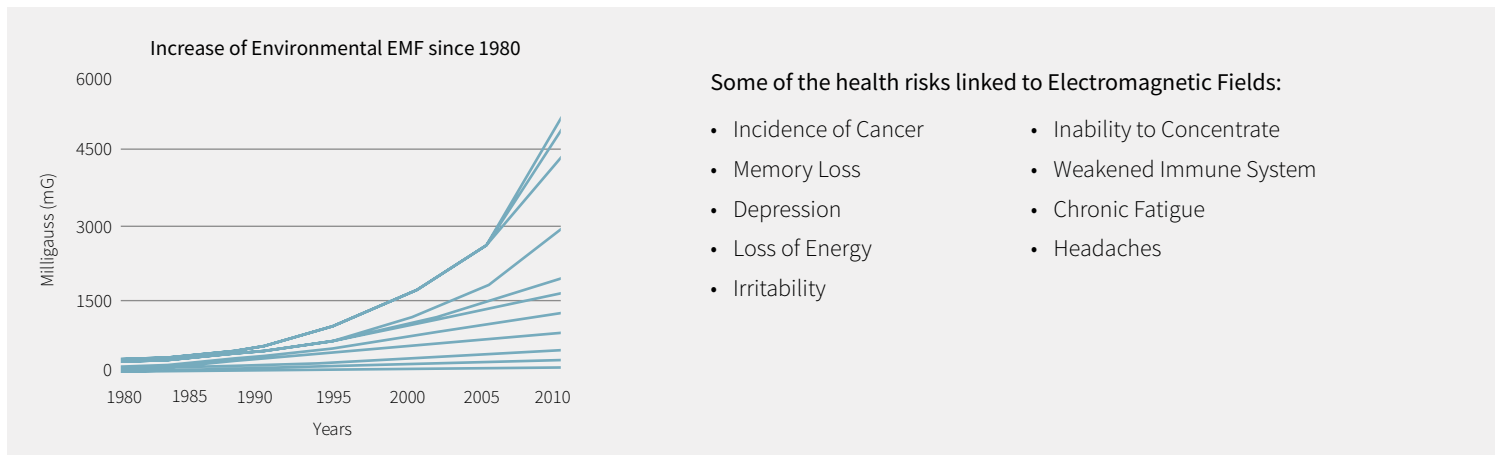

## EMF/ELF Extra Shielded Wiring = Electromagnetic Safety

True Wave™ infrared heaters are the most effective and safest infrared heaters available. We have developed our own patented technologies that cancel out both EMF (Electromagnetic Fields) and ELF (Extremely Low Frequencies). We guarantee that you will not experience any harmful wavelengths when you are in your sauna. EMF levels tested consistently show an average of less than 1mg and our ELF levels test 3-5 times below the threshold of concern set by the World Health Organization (WHO). Many of our competitors’ saunas tested with levels 20 times or more above this same threshold of concern. Our proprietary True Wave™ heaters were the first low EMF carbon-based heaters in the market and revolutionised the entire infrared sauna industry.

## Patented Technology Keeps Our Saunas Safe

We manufacture our saunas with advanced heater systems to keep you and your family safe. We go to extra lengths such as shielding our heater wiring in metal conduit and twisting the wires inside the conduit to reduce the EMF levels even further. Lastly, we shield all electrical components to help block the EMF/ELF and ground the heater to further eliminate any stray electrical wavelengths at their source.

## Low EMF (Electromagnetic Field)

[View EMF certificate](#)

Our exclusive manufacturing process and patented far infrared heater technologies reduces EMF levels to virtually zero where you are sitting ensuring the highest level of safety. This has been confirmed by third party testing. When EMF levels are measured in the seating area inside a Clearlight® infrared sauna, EMF levels are virtually undetectable. Measurements have been verified by VitaTech Electromagnetics.

## Low ELF (Extremely Low Frequency)

Extremely low frequency (ELF) is easily detected standing near any utility power line. You can also be exposed when operating electrical appliances. When testing our low ELF technology, our saunas measured at 200 mV – five times below the threshold of concern, as opposed to many competitor models, where ELF levels were found to exceed 20,000 mV – 20 times above the threshold of concern. When we test our saunas without an actual person inside, our ELF metrics are equally impressive. The Threshold of Concern is 10 Volts/Meter (V/m). Clearlight® Infrared Saunas averaged 3.4 V/m, whereas our competitors saunas measured 300+ V/m.

# Clearlight Heater Test: Emissivity and Absorption

**Emissivity:** the measure of an object's ability to emit infrared energy.

## Emissivity Test Results:

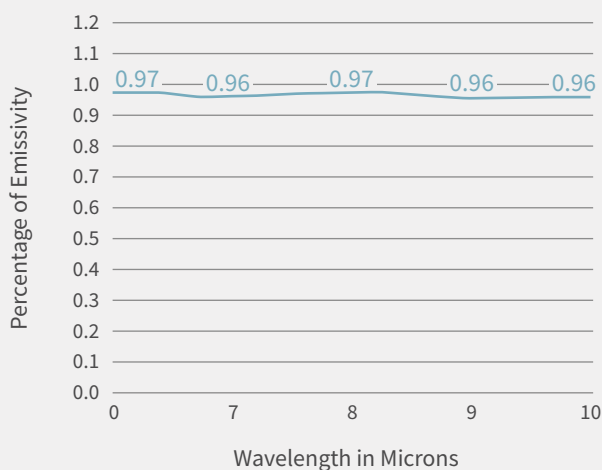

\* **Please note:** Emissivity is only one measure of a heater's effectiveness. To get positive results, we must also determine the ability of the infrared energy to travel through the air and then be absorbed by the body. This is the true measure of the heater's effectiveness.

**Energy Absorption:** The measure of infrared penetration and retention in the human body. Clinical studies show that the addition of our proprietary ceramic powder in our True Wave II heaters substantially increases emissivity, waveform stability and heat absorption (see pictures below).

## Absorption Test results: I & I EPOS 2011

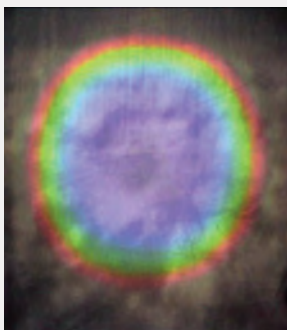

True Wave II Carbon/Ceramic  
99% Absorption

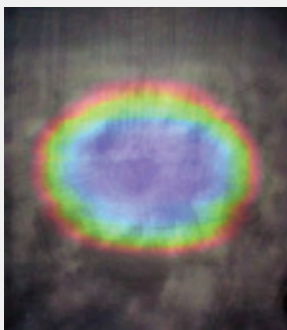

Plain Ceramic Heater  
67% Absorption



Plain Carbon Heater  
73% Absorption

# Infrared Saunas Safety Certifications and Testing

All Clearlight® brand saunas are rigorously tested and certified for product safety. Your health is our number one concern.

## Electrical and Hazardous Materials Safety



The ETL service mark is verified and certified by Intertek, a third-party safety rating company. This mark assures the highest level of safety and compliance for all components and saunas.

### ETL certification

[View certificate](#)



Compliance with the CE standard implementation starts during the design and manufacturing process relies on the manufacturers themselves both in Australia and New Zealand.

### CE

[View certificate](#)



Our compliance with RoHS, (Restriction of Hazardous Substances) is verified by RoHS standards and certified by Intertek.

### RoHS

[View certificate](#)

### VOC's

We have designed and built our saunas to be free of any harmful VOCs (Volatile Organic Compounds.) To verify this, we regularly utilise third party labs to perform rigorous VOC testing. Air samples are first tested in a clean room. The sauna is then set up and a second round of samples are taken. Next the sauna is programmed to heat up and run at maximum temperature for over two hours at which time another series of air samples are taken inside and outside of the sauna. All results are then compiled, compared and recorded. This way we know that no VOCs will be present during your sauna session.

### VOC's

[View certificate](#)

### MSDS

The Material Safety Data Sheet (MSDS) confirms the ingredients used in our varnishes, glues and wood sealers contain no toxic or hazardous materials.

### MSDS Glue

[View certificate](#)

### MSDS Varnish

[View certificate](#)

### MSDS Water-based Wood Coating

[View certificate](#)

## Our Safety Guarantee:

We guarantee that your Clearlight® infrared sauna will be safe and below any threshold of concern.